

Air Sensor

SAC Ex FCS Ex CCS Ex

Manual



Air Sensor

SAC Ex FCS Ex CCS Ex

ATEX Certified

AQ M-Tech AB

Manual version 2.3

September 2018

AQ M-Tech AB
Bolandsgatan 10
SE-753 23 Uppsala
Sweden
phone +46 184702900
www.aqgroup.com/en/aqm-tech/aq-m-tech
info.aqmtch@aqgroup.com

Table of contents

1. Manufacturer information	5
Manufacture Declaration of Conformity	5
Manufacture Declaration of Conformity to Ex-standards	5
Limited Warranty	5
Returning the Air Sensor	5
Warning	5
2. Introduction	6
Air Sensor	6
Ultrasound Controller	6
3. Functional Description	6
4. Installing the Air Sensor	6
Installing the Air Sensor.....	6
Vertical or Horizontal Installation	6
5. Connecting the Air Sensor	6
Connecting the Air Sensor Ex using barriers	6
Cable	7
Choosing a barrier	7
Ex-barriershields.....	7
Connecting Air Sensor SAC Ex via barriers to Ultrasound Controller D72 or DP72 (or D128)	8
Connecting Air Sensor FCS Ex via barriers to Ultrasound Controller D72	9
or DP72 (or D128)	9
Connecting Air Sensor CCS Ex via barriers to Ultrasound Controller D72	10
or DP72 (or D128)	10
6. Settings, Calibration and Troubleshooting	11
7. Ex description	11
Information written on Air Sensor SAC Ex label	11
Information written on Air Sensor FCS Ex label	12
Information written on Air Sensor CCS Ex label.....	12
8. Specifications for Air Sensor SAC Ex, FCS Ex and CCS Ex	13
Air Sensor SAC Ex dimensions	14
Air Sensor FCS Ex dimensions	14
Air Sensor CCS Ex dimensions.....	15
Cable for Air Sensor SAC Ex.....	15
Cable for Air Sensor CCS Ex	15

1. Manufacturer information

AQ M-Tech AB operates a policy of on-going development and reserves the right to make changes and improvements to any of the products described in this user guide without prior notice. Any changes on the products will take place only after consulting the certifying body to ensure that the changes will not affect the Ex safety.

Under no circumstances shall AQ M-Tech be held responsible for any loss or indirect damage howsoever caused. The contents of this document are provided as it is. AQ M-Tech AB reserves the right to revise this document or withdraw it at any time without prior notice.

Manufacture Declaration of Conformity

Manufacturer: AQ M-Tech AB Sweden declares, that the product: Air Sensor marked with CE-label conforms with the following standards: EN 61000-6-2:2005, EN 61000-6-4:2007, EN55011 (Group 1, Class B).

The Air Sensor is RoHS Compliant, directive 2011/65/EU. Air Sensor marked with  conforms to WEEE directive 2012/19/EU.

Manufacture Declaration of Conformity to Ex-standards

Manufacturer: AQ M-Tech AB Sweden declares, that the product: Air Sensor marked with ATEX-label conforms with the following Ex-standards:

IEC 60079-0:2011, 6th Edition (incl. Corrigendum 1 and 2)

IEC 60079-11:2011, 6th Edition

IEC 60079-26:2014, 2nd Edition

IEC 60079-0:2012 + A11:2013

IEC 60079-11:2012

IEC 60079-26:2015

Limited Warranty

AQ M-Tech AB warrants to the original end user that the Air Sensor is free from any defects in materials or workmanship for a period of one year from the date of purchase. During the warranty period, should the Air Sensor have indications of failure due to faulty workmanship or materials, AQ M-Tech AB will replace it with no charge. This warranty shall not apply if the Air Sensor is modified, misused or subjected to abnormal working conditions.

Replacement as provided under this warranty is the only remedy of the purchaser. The purchaser pays freight to AQ M-Tech AB. AQ M-Tech AB shall in no event be held liable for indirect or consequential damages of any kind or character to the purchaser.

Returning the Air Sensor

If the Air Sensor is to be discarded or if it shall undergo a warranty commission it shall be sent back to AQ M-Tech AB. See below for address. The Air Sensor must be clean and free from any harmful contaminations. A certificate shall be attached confirming the cleaning.

Warning

The Air Sensor is intended to be used with the Ultrasound Controller manufactured by AQ M-Tech AB. AQ M-Tech AB takes no responsibility for any possible damage that could happen if the Air Sensor is connected to any equipment not manufactured by AQ M-Tech AB.

2. Introduction

Air Sensor

Liquid flowing through the Air Sensor is monitored with ultrasound and the presence of gas or particles is detected by the connected Ultrasound Controller. The Air Sensor is reliable and easy to use. It is turned from one piece and the inside is completely smooth with low Ra-value.

Ultrasound Controller

Ultrasound Controller D72 or DP72 or D128 is recommended for use with the Air Sensors. It can connect two Air Sensors.

3. Functional Description

See the Ultrasound Controller manual.

4. Installing the Air Sensor

Installing the Air Sensor

One or two Air Sensors can be connected to one Ultrasound Controller D72, DP72 or D128. The Air Sensor has TC-connections (tri-clamp) and it is important to install and connect the Air Sensor properly to avoid leakage. When installing the Air Sensor it is also necessary to take into consideration external heating and cooling sources. The Air Sensor is designed to be used in normal atmospheric pressure (0.8 bar – 1.1 bar) with normal oxygen content.

A person with the required knowledge should perform installation.

Vertical or Horizontal Installation

We recommend installing the Air Sensor with vertical flow due to lower risk of bubbles lingering inside.

If however the Air Sensor is installed with horizontal flow the rotational orientation of the Air Sensor is important. For maximum bubble sensitivity at slow flow rate, when the Air Sensor is installed with horizontal flow, the Air Sensor should be turned so that the cable connector is up. If lower sensitivity is wanted at slow flow rate, the Air Sensor can be turned so the cable connector is down.

5. Connecting the Air Sensor

Connecting the Air Sensor Ex using barriers

The Ultrasound Controller D72, DP72 or D128 is not ex-certified and intrinsically safe barriers must be used to connect the Air Sensor Ex. The diagrams below show how to connect two Air Sensors via two barriers to one Ultrasound Controller. It is important to install the barriers and the sensors according to EN 60079-14 and to summarize the voltage and current according to appendix B.

One zener barrier is needed for each Air Sensor.

In the diagrams, the cable type between the Ultrasound Controller and the barriers is the same type as between the barriers and the Air Sensors. If another cable type is used it must be shielded. The length of the unshielded part of the cables should be max 40mm.

Cable

The cable connects the Air Sensor to the barriers hazardous side.

The cable for Air Sensor SAC Ex connects via a connector on the Air Sensor. The cable is available in different length and the maximum cable length is 40m.

The cable for Air Sensor FCS Ex is permanently attached to the Air Sensor. The maximum cable length is 10m.

The cable for Air Sensor CCS Ex connects via a connector on a very short cable permanently attached to the Air Sensor and the maximum cable length is 40m.

The cable-shield is important because it prevents external noise from entering.

NOTE! The unshielded part of the cables should be max 40mm.

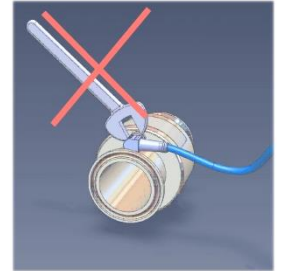

Choosing a barrier

The barrier must be chosen according to EN 60079-14, but there are also measurement considerations for choosing the barrier:

1. The barrier must use resistive current limitation.
2. The barrier must be made for unbiased AC current relative ground.
3. The barrier voltage should be minimum $\pm 8V$ AC
4. The barrier resistance should be maximum 110Ω
5. The barrier attenuation at 2MHz should be maximum 10dB.
6. The barriers capacitance to ground should be maximum 3nF.

Recommended barrier: Pepperl+Fuchs Z960.

Ex-barriershields

Shielding aluminum plates must be placed outside each group of barriers belonging to each Ultrasound Controller.

The zener barriers are not shielded, so without shielding aluminum plates, noise can be transferred between barriers belonging to different Ultrasound Controllers. Also unshielded parts of the cables should be short to prevent noise.

Shielding aluminum plate must be ordered separately, item no: Ex-barriershield.

The Ex-barriershield snaps on to the DIN-rail next to the intrinsically safe Zener barriers, see picture.

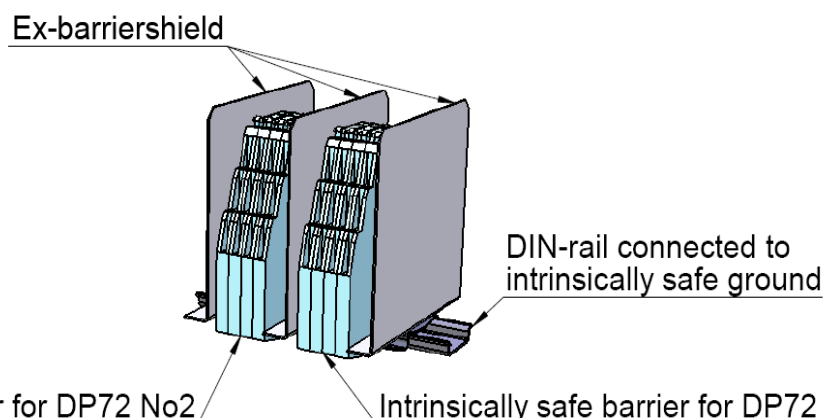

Connecting Air Sensor SAC Ex via barriers to Ultrasound Controller D72 or DP72 (or D128)

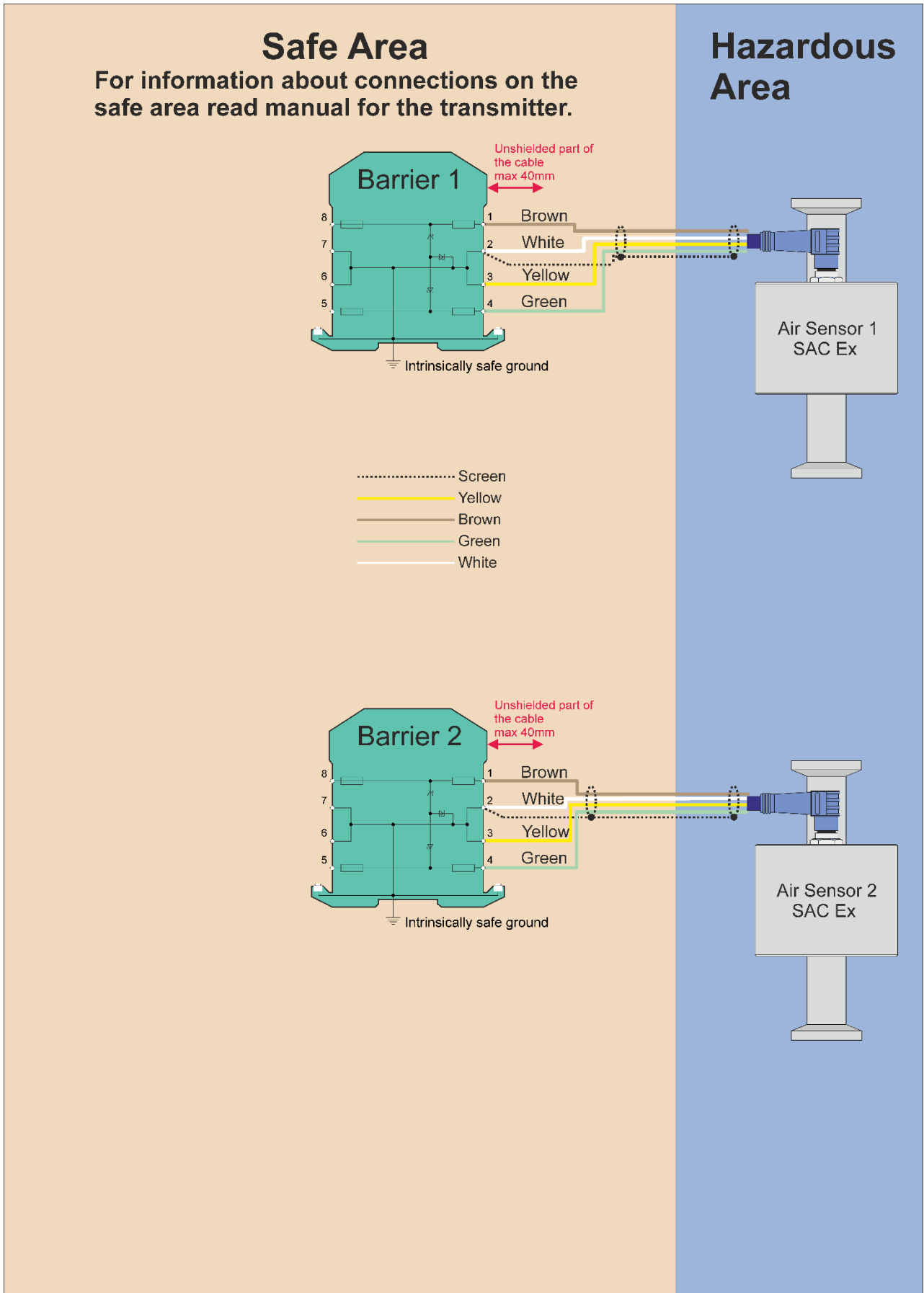

Connecting Air Sensor FCS Ex via barriers to Ultrasound Controller D72 or DP72 (or D128)

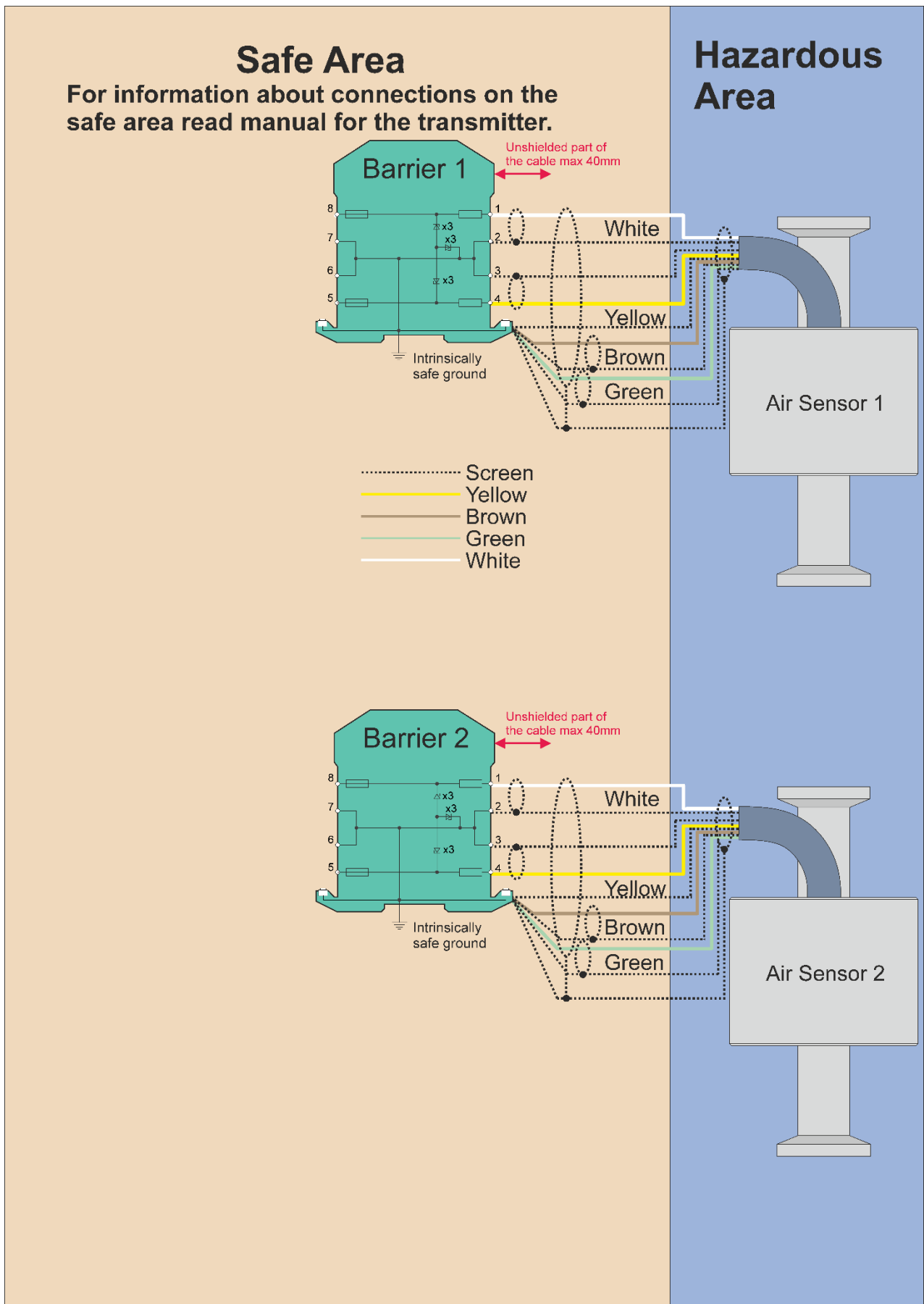

Connecting Air Sensor CCS Ex via barriers to Ultrasound Controller D72 or DP72 (or D128)

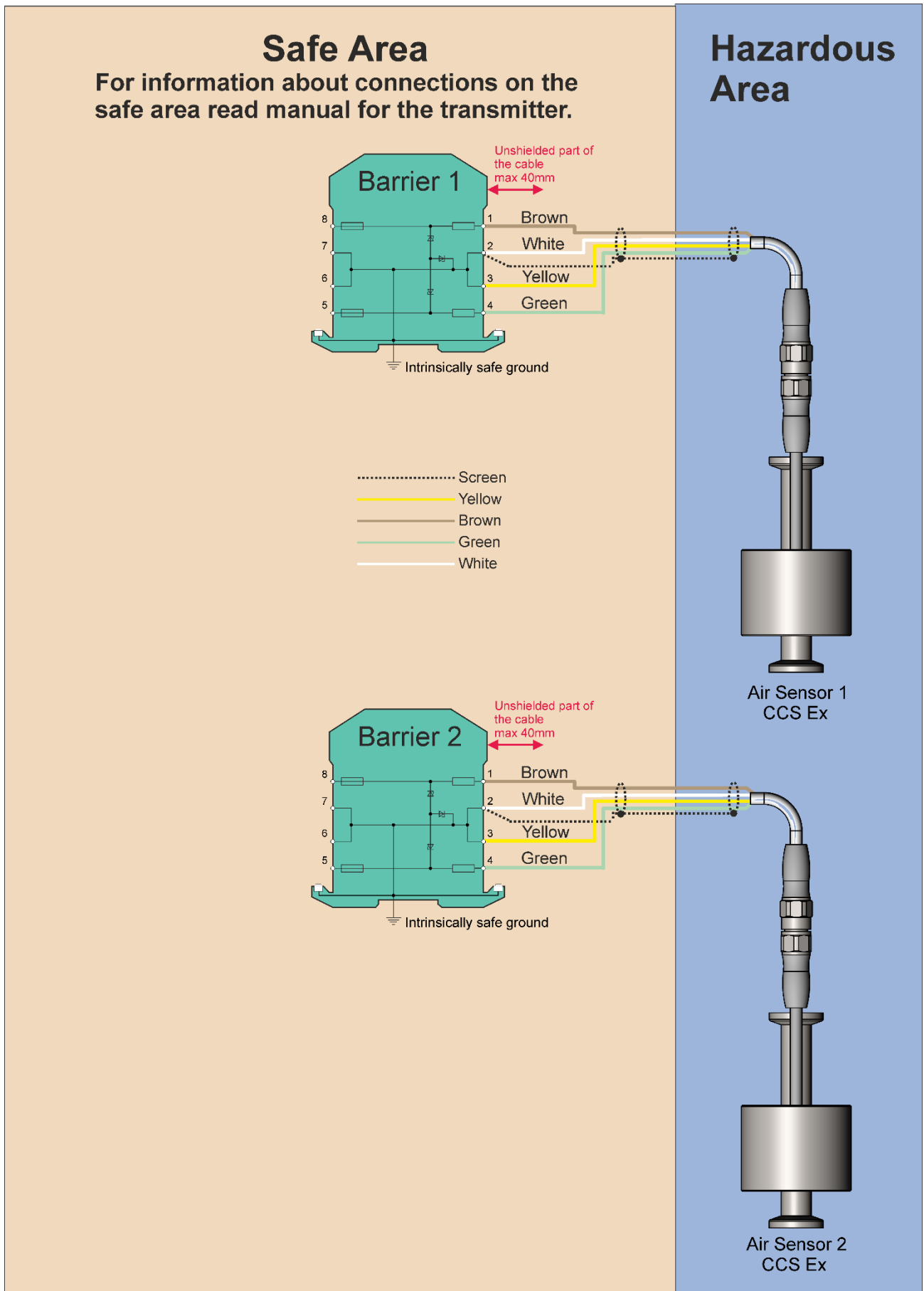

6. Settings, Calibration and Troubleshooting

See Ultrasound Controller manual.

7. Ex description

The Air Sensor is made to be used in Apparatus-group IIB and Equipment-group 1/2G. The inside of the conduit of the sensor is designed to be exposed to zone 0 and the remaining parts to zone 1. The sensor is transmitting ultrasound into zone 0. Notice that the Ultrasound Controller is not Ex certified and barriers must be used to connect the Air Sensors. The intrinsically safe circuit inside the sensor is isolated from earth.

Common regulations for installation and maintenance of explosive protected electrical equipment shall be observed. (EN 60079-14 and EN 60079-17 in European countries connected to CENELEC). A person with the required knowledge should perform installation.

Special conditions for use of Air Sensor SAC Ex and FCS Ex and CCS Ex:

- The enclosure of the Air sensor must be connected to earth via the mounting in the conduit system. A person with the required knowledge should perform installation
- Any external sources of heating must be considered at installation to not exceed the maximum ambient temperature +60°C for the sensors

Information written on Air Sensor SAC Ex label

Air Sensor	Made in Sweden
Type	see Technical specifications for SAC Ex
Inner diameter	see Technical specifications for SAC Ex
Ex Class	CE 0402  II 1/2 G Ex ib IIB T4 Ga/Gb
SP No.	SP17ATEX3654X
Ambient temp.	Tamb: -20 to +60 °C
Max input voltage	Ui: 13,0 V
Max current input	Ii: 0,70 A
Max power input	Pi: 1,20 W
Inner capacitance	Ci: 200 nF
Inner inductance	Li: 50 µH



Information written on Air Sensor FCS Ex label



Air Sensor	Made in Sweden
Type	see Technical specifications for FCS Ex
Inner diameter	see Technical Specifications for FCS Ex
Ex Class	CE 0402 Ex II 1/2 G Ex ib IIB T4 Ga/Gb
SP No.	SP 17ATEX3654X
Ambient temp.	Tamb: -20 to +60 °C
Max input voltage	Ui: 13,0 V
Max current input	Ii: 0,70 A
Max power input	Pi: 1,20 W
Inner capacitance	Ci: 200 nF
Inner inductance	Li: 50 µH

Information written on Air Sensor CCS Ex label

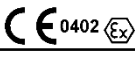

Air Sensor	Made in Sweden
Type	see Technical specifications for CCS Ex
Inner diameter	see Technical Specifications for CCS Ex
Ex Class	CE 0402 Ex II 1/2 G Ex ib IIB T4 Ga/Gb
SP No.	SP 17ATEX3654X
Ambient temp.	Tamb: -20 to +60 °C
Max input voltage	Ui: 13,0 V
Max current input	Ii: 0,70 A
Max power input	Pi: 1,20 W
Inner capacitance	Ci: 200 nF
Inner inductance	Li: 50 µH

Manufacturing year

 AQ M-Tech AB Bolandsgatan 10 SE-753 23 Uppsala Sweden Phone: +46 (0)18 470 29 00 www.aqtech.se	Air Sensor Made in Sweden	
	Serial no. xxxx Type xxxxx-xx Ex (xxxx)	
	Inner diameter IDxmm/TCxmm Tamb: -20°C to +60°C II 1/2G Ex ib IIB T4 Ga/Gb SP17ATEX3654X	
	Ui: 13,0 V Ii: 0,70 A Pi: 1,20 W Ci: 200 nF Li: 50 µH	

Symbol	Description
	Mark for ATEX certified electrical equipment for explosive atmospheres.
	This symbol indicates that the waste of electrical and electronic equipment must not be disposed as unsorted municipal waste and must be collected separately.
	The Air Sensor meets all the essential requirements of applicable EU directives.

Manufacturing year

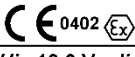
 AQ M-Tech AB Bolandsgatan 10 SE-753 23 Uppsala Sweden Phone: +46 (0)18 470 29 00 www.aqtech.se	Air Sensor Made in Sweden	
	Serial no. xxxx Type xxxxx-xx Ex (xxxx)	
	Inner diameter IDxmm/TCxmm Tamb: -20°C to +60°C II 1/2G Ex ib IIB T4 Ga/Gb IECEx RISE 18.0001X SP17ATEX3654X	
	Ui: 13,0 V Ii: 0,70 A Pi: 1,20 W Ci: 200 nF Li: 50 µH	

Air Sensors with IECEx number are only available via GE Healthcare.

8. Specifications for Air Sensor SAC Ex, FCS Ex and CCS Ex

Operating temperature range	0°C to 60°C
Maximum temperature range*	-20°C to 60°C
Maximum pressure	1Mpa / 10 bar g at operating temperature range
Protection class	IP67
Finish in pipe (Ra-value)	<0,375 µm / <15 micro inch
Connector type	SAC: M8 4pin, CCS: M12 4pin, FCS: no connector

*Proper indication of bubbles is not guaranteed at temperatures outside operating temperature range.

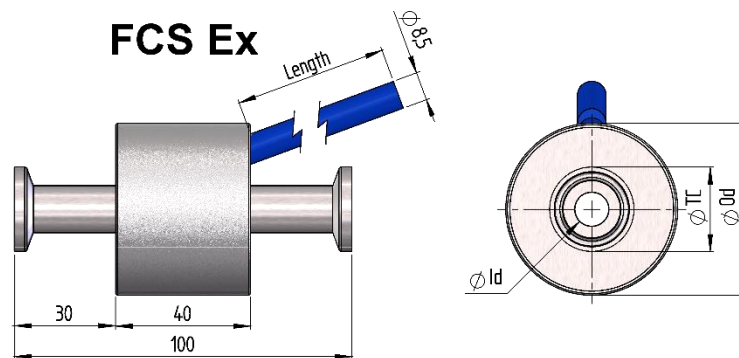

WG-Cable for Air Sensor SAC Ex

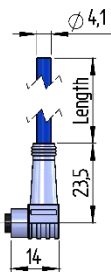

SAC Ex

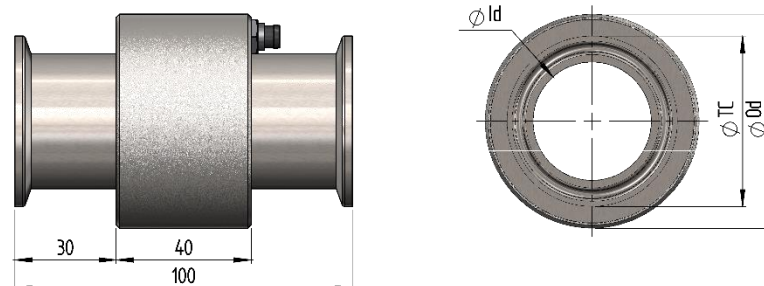

Extension CCS-Cable for Air Sensor CCS Ex

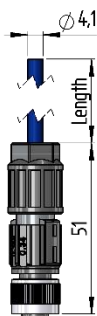

CCS Ex

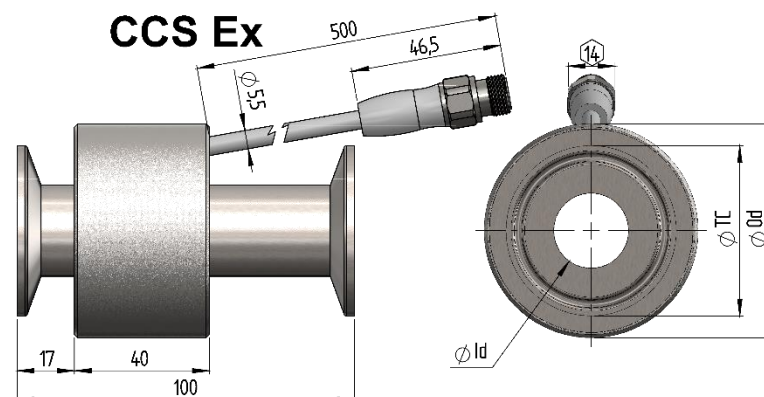

All dimensions are in millimeters

Air Sensor SAC Ex dimensions

Model number	Inner diameter (mm)	Outer diameter (mm)	Tube connection	Material Stainless steel	Standard cable length *
SAC10-25-Ex	10	51	TC 25mm	316L	WB-Cable-7m
SAC16-25-Ex	16	51	TC 25mm	316L	WB-Cable-7m
SAC16-50-Ex	16	64	TC 50mm	316L	WB-Cable-7m
SAC22-50-Ex	22	64	TC 50mm	316L	WB-Cable-7m
SAC35-50-Ex	35	64	TC 50mm	316L	WB-Cable-7m
SAC46-64-Ex	46	76	TC 64mm	316L	WB-Cable-7m
SAC60-77-Ex	60	102	TC 77mm	316L	WB-Cable-7m

* A WB-Cable should be used to connect to the Air Sensor SAC Ex. Maximum allowed cable length is 40m.

Air Sensor FCS Ex dimensions

Model number	Inner diameter (mm)	Outer diameter (mm)	Tube connection	Material Stainless steel	Standard cable length *
FCS10-25-Ex	10	51	TC 25mm	316L	Fixed 5m
FCS16-25-Ex	16	51	TC 25mm	316L	Fixed 5m
FCS16-50-Ex	16	64	TC 50mm	316L	Fixed 5m
FCS22-50-Ex	22	64	TC 50mm	316L	Fixed 5m
FCS35-50-Ex	35	64	TC 50mm	316L	Fixed 5m
FCS46-64-Ex	46	76	TC 64mm	316L	Fixed 5m

* The Air Sensor FCS Ex is connected via a cable which is permanently attached to the Air Sensor. Maximum allowed cable length is 10m.

Air Sensor CCS Ex dimensions

Model number	Inner diameter (mm)	Outer diameter (mm)	Tube connection	Material Stainless steel	Standard cable length
CCS9.4-25-Ex	9.4	51	TC 25mm	1.4435	Fixed 0.5m
CCS15.75-25-Ex	15.75	51	TC 25mm	1.4435	Fixed 0.5m
CCS15.75-50-Ex	15.75	64	TC 50mm	1.4435	Fixed 0.5m
CCS22.1-50-Ex	22.1	64	TC 50mm	1.4435	Fixed 0.5m
CCS34.8-50-Ex	34.8	64	TC 50mm	1.4435	Fixed 0.5m
CCS47.5-64-Ex	47.5	76	TC 64mm	1.4435	Fixed 0.5m
CCS60.2-77-Ex	60.2	102	TC 77mm	1.4435	Fixed 0.5m

* The Air Sensor CCS Ex has a short cable with a connector. A CCB-Cable should be used to connect to the Air Sensor. Maximum allowed cable length is 40m.

Cable for Air Sensor SAC Ex

Cable order-number	Color	Length
WB – Cable – 7m	Blue	7m
WB – Cable – 20m	Blue	20m
WB – Cable – 40m	Blue	40m

Cable for Air Sensor CCS Ex

Cable order-number	Color	Length
CCB – Cable – 7m	Blue	7m
CCB – Cable – 20m	Blue	20m
CCB – Cable – 40m	Blue	40m